

Université d'Ottawa  
Faculté de génie

Département de  
Génie Civil



uOttawa

L'Université canadienne  
Canada's university

University of Ottawa  
Faculty of Engineering

Department of  
Civil Engineering

CVG 1507: Examen partiel  
vendredi 4 mars 2016

Durée de l'examen: 1:30  
Calculatrices non-programmables permises

Question	Points
1	20
2	20
3	20
Total	60

Nom: \_\_\_\_\_

Numéro d'étudiant: \_\_\_\_\_

---

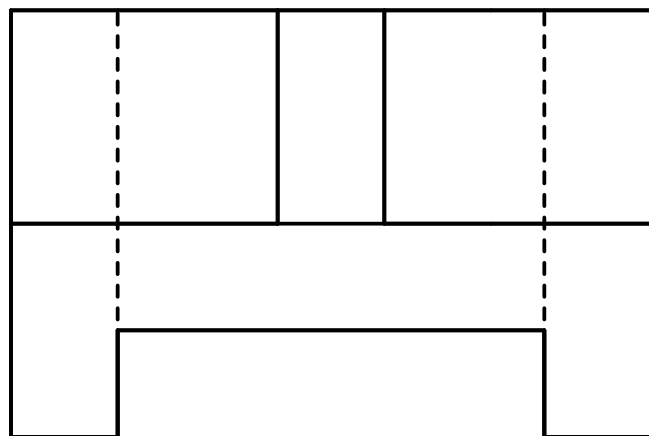
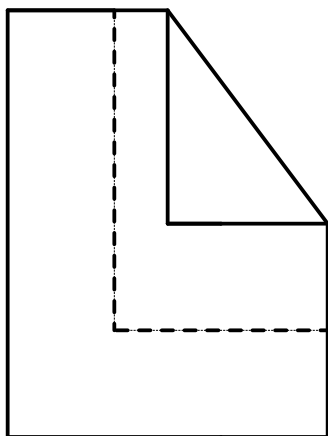
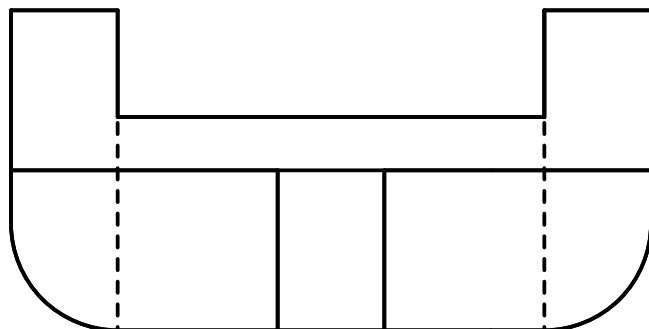
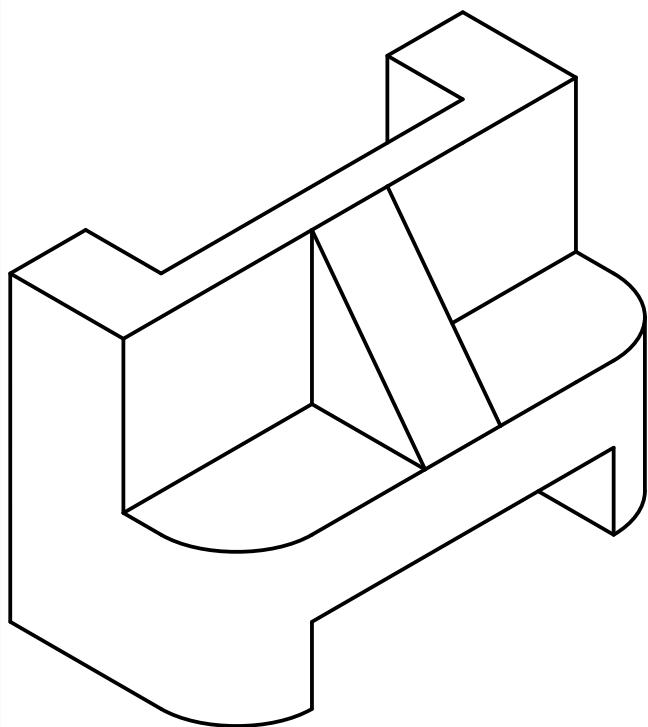

Q1 Dessinez les projections orthogonales de l'objet illustré ci-dessus.



TITRE :

Projections orthogonales

Dessine par: \_\_\_\_\_

Verifie par: \_\_\_\_\_

Echelle : \_\_\_\_\_

Section : \_\_\_\_\_

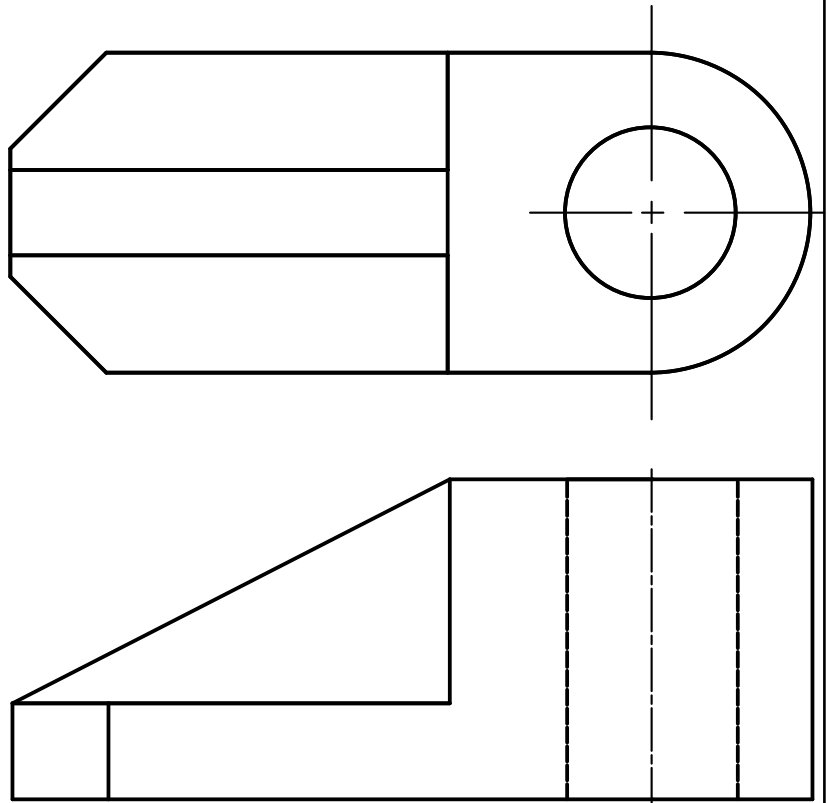
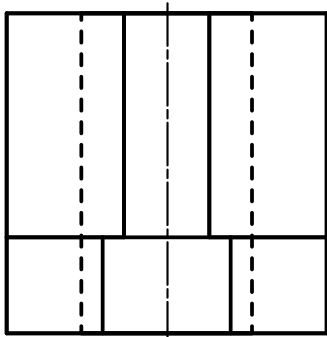

Q2. Dessinez la vue manquante de ci-dessus.



TITRE: **Vue Manquante**

Dessine par: \_\_\_\_\_

Verifie par: \_\_\_\_\_

Echelle : \_\_\_\_\_

Section : \_\_\_\_\_

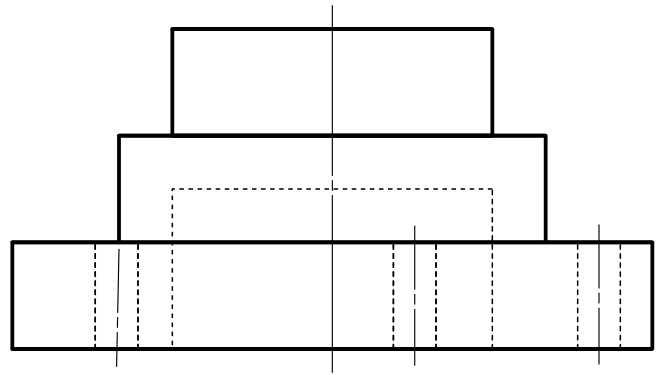
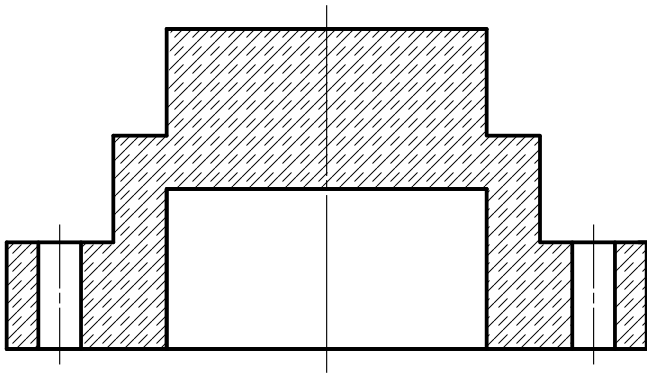
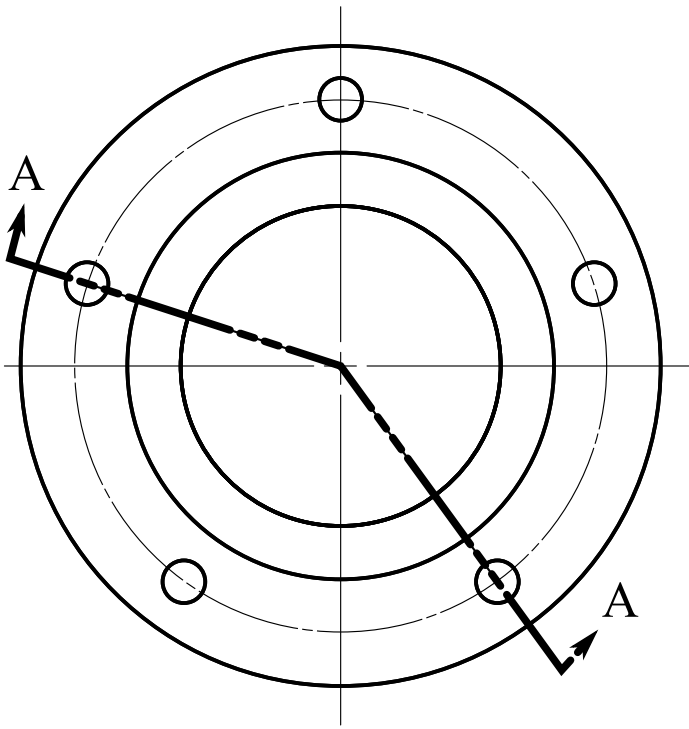

Q3 Dessinez la section indiquée sur la vue de plan.



TITRE :

Section

Dessine par : \_\_\_\_\_

Verifie par : \_\_\_\_\_

Echelle : \_\_\_\_\_

Section : \_\_\_\_\_